



Installation Instructions Cable Bikini Top

Vehicle Application:
Jeep® Wrangler Unlimited JL 2018-2023
Part Number 52608

Installation Tips

Before you begin installing your new Cable Bikini Top, please read all the instructions thoroughly.











WARNING Do not rely in any way on the components of this product to protect against injury or death in the event of an accident. Never operate the vehicle in excess of manufacturer's specifications.

Read and follow, precisely, all installation instructions provided when installing this product. Failure to do so may result in a poor fit and could place occupants of the vehicle in a potentially dangerous situation.



WEAR SEAT BELTS AT ALL TIMES

CAUTION Safety glasses should be worn at all times when installing this product.

Tools		Installation Time	Support
 Safety Glasses	 T25 - T40 - T50 Torx Drivers Phillips Screw Driver	 30 minutes	We're here to help! Go to: https://www.bestop.com and click on Need Help?
 Ratchet	 - OR -  13mm Socket 13mm Wrench	Skill Level     1 - Easy	
		 https://www.bestop.com/video-library	



Installation Instructions Cable Bikini Top

Vehicle Application:
Jeep® Wrangler Unlimited JL 2018-2023
Part Number 52608

Sugerencias de Instalación

Antes de empezar a instalar esta unidad, lea atentamente todas las instrucciones.

Para un buen ajuste:

Para facilitar la instalación, el producto debe instalarse a temperaturas superiores a 72 °F (22 °C).

Por debajo de esta temperatura, la tela puede encogerse una pulgada o más, lo que dificultaría su ajuste al vehículo.

Es normal que la tela se contraiga o arrugue cuando está guardada en la caja de empaque. A los pocos días después de la instalación, la tela se relajará y las arrugas desaparecerán.



ADVERTENCIA

Este producto se diseñó principalmente para mejorar la apariencia del vehículo y proteger a los ocupantes de las condiciones climáticas comunes. De ninguna manera piense que los componentes de este producto pueden servir como medio de contención para los ocupantes del vehículo o que pueden protegerlos contra lesiones o la muerte en caso de accidente. Este producto no protegerá a los ocupantes contra caídas de objetos. Nunca conduzca este vehículo fuera de las especificaciones del fabricante.

USE LOS CINTURONES DE SEGURIDAD EN TODO MOMENTO

Lea y siga con precisión todas las instrucciones de instalación que se proporcionan para instalar este producto. Si no lo hace, podría producirse un mal ajuste que colocaría a los ocupantes del vehículo en una situación potencialmente peligrosa.



PRECAUCIÓN

Debe usar gafas protectoras en todo momento durante la instalación de este producto.

Conseils pour l'installation

Lire toutes les instructions au complet avant de commencer l'installation de cet assemblage.

Pour un ajustement sans problème :

Afin de faciliter l'installation, ce produit doit être installé à des températures au-dessus de 72 °F (22 °C).

Sous cette température, le tissu peut rétrécir d'un pouce (2,5 cm) ou plus, ce qui rendra l'ajustement sur le véhicule difficile.

Il est normal que le tissu rétrécisse et plisse pendant qu'il est dans la boîte d'expédition. En quelques jours après l'installation, le tissu se détendra et les plis disparaîtront.



AVERTISSEMENT

Ce produit est conçu principalement pour améliorer l'apparence du véhicule et pour protéger les occupants des conditions météorologiques usuelles. Ne jamais se fier aux composants de ce produit pour se protéger de blessures ou de la mort en cas d'accident. Ce produit ne protégera pas les occupants des chutes d'objets. Ne jamais utiliser le véhicule au-delà des caractéristiques techniques indiquées par le fabricant.

PORTER UNE CEINTURE DE SÉCURITÉ EN TOUT TEMPS

Lire et suivre, très fidèlement, toutes les instructions d'installation fournies lors de l'installation de ce produit. Ne pas suivre cette consigne peut causer une installation inadéquate et mettre les occupants du véhicule dans une situation potentiellement dangereuse.



MISE EN GARDE

Des lunettes de sécurité doivent être portées en tout temps lors de l'installation de ce produit.







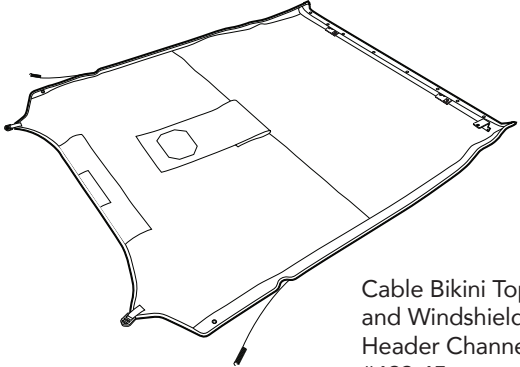
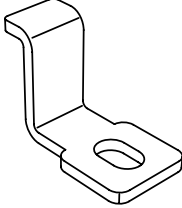
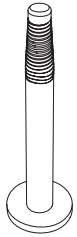
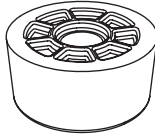
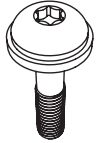

Installation Instructions Cable Bikini Top

Vehicle Application:
Jeep® Wrangler Unlimited JL 2018-2023
Part Number 52608

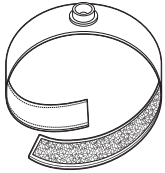
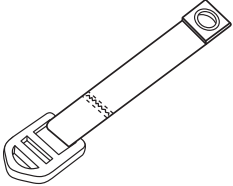
Parts List

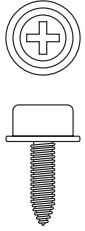
- Required parts for installation - Page number in Installation Guide

Sections 1 to 2		Bikini Top/Header Channel, Latch Receiver Bracket & Fasteners			Pages 4 to 5 of Guide
 <p>Cable Bikini Top and Windshield Header Channel #423.45</p>	 <p>Latch Receiver Z-Bracket Part #596.45 Qty. 2</p>	 <p>M8 x 1.25 X 80mm Button Head Socket Cap Screw/Washer Part #532.23 Qty. 2</p>	 <p>Bolt Spacer Bezel Part #574.05 Qty. 2</p>	 <p>M8x1.25x38 Button Head Socket Cap Screw/Washer Part #532.17 Qty. 2</p>	
Sections 3 to 6		Fasteners, Straps, Tail Clips			Pages 6 to 9 of Guide
 <p>M8 Nylon Lock Nut #434.12 Qty. 2</p>	 <p>Hook & Loop Snap Straps #589.20 Qty. 2</p>	 <p>Buckle Straps Qty. 2</p>	 <p>Snap Straps Part # 591.20 - 21" Qty. 2 Part # 600.64 - 26" Qty. 2</p>	 <p>Snap Stud Screw #8x5/8" Part #728221 Qty. 4</p>	
			 <p>Tail Clip Part #338.24 Qty. 4</p>		

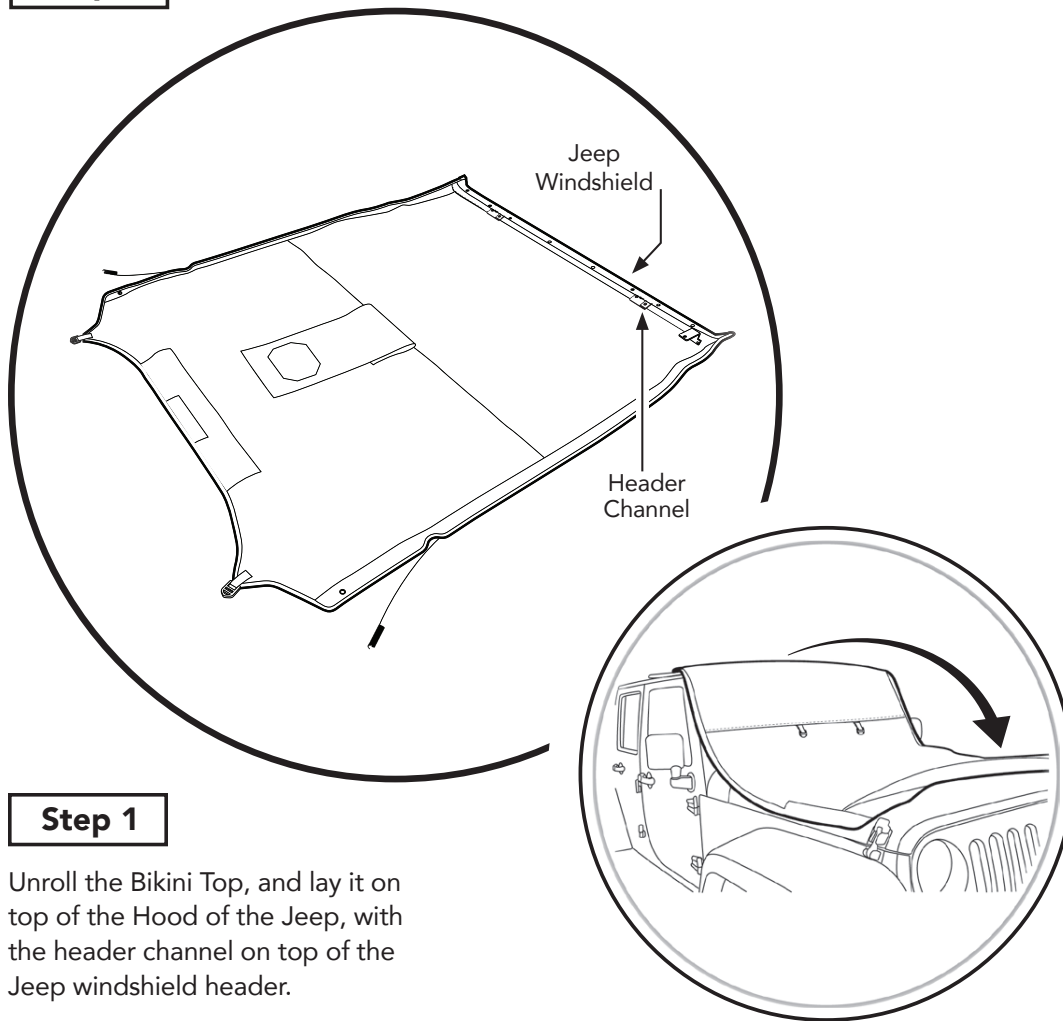
Step 1**Step 1**

Unroll the Bikini Top, and lay it on top of the Hood of the Jeep, with the header channel on top of the Jeep windshield header.

Step 1	423.45	532.23	596.45	574.05
---------------	--------	--------	--------	--------

Hardware

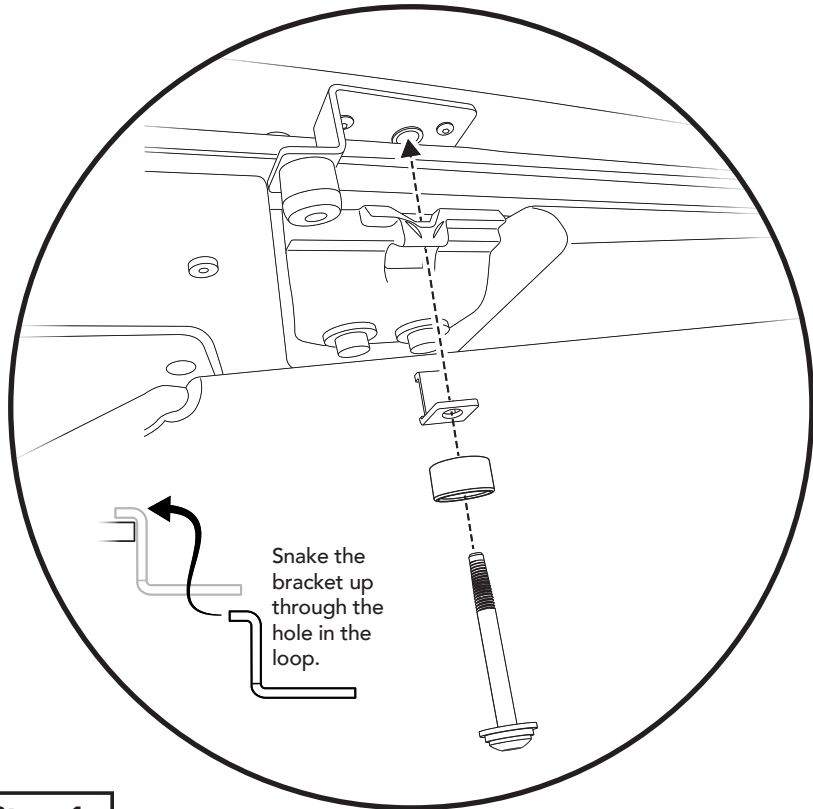

Windshield Header Channel
Part #423.45
With Bikini Top attached
(Bikini not shown)

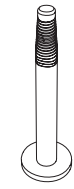

M8 x 1.25 X 80mm
Button Head
Socket Cap
Screw/Washer
Part #532.23
Qty. 2

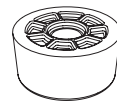

Bolt Spacer Bezel
Part #574.05
Qty. 2

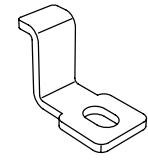

Latch Receiver Z-Bracket
Part #596.45
Qty. 2

Tools



T40 Torx
Driver

Step 1

Secure the Bikini Windshield Header Channel #423.45 to the Jeep windshield header, using one (1) Latch Receiver Bracket #596.45, one (1) M8x1.25x80mm Button Head Socket Cap Screw/Washer #532.23, and one Bolt Spacer Bezel #574.05 per side.

The Latch Receiver Bracket and the M8x1.25x80mm long Screw/Washer with additional M8 washer and Spacer Bezel are attached from the underside to secure the Latch Receiver Bracket to the windshield header.

The Latch Receiver Bracket must be snaked up through the hole in the windshield header latch loop, so that the lip at the top of the bracket catches the horizontal edge on the header.

Do not tighten this fastener until after installing the Button Head Socket Screw #532.17 in Section 3 Step 1 (on the following page).

Step 1

532.17

434.12

Hardware

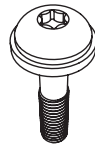

M8x1.25x38
Button Head
Socket Cap
Screw/Washer
Part #532.17
Qty. 2



M8 Nylon Lock Nut
#434.12
Qty. 2

Tools



13mm Wrench



T50 Torx
Driver

Step 3

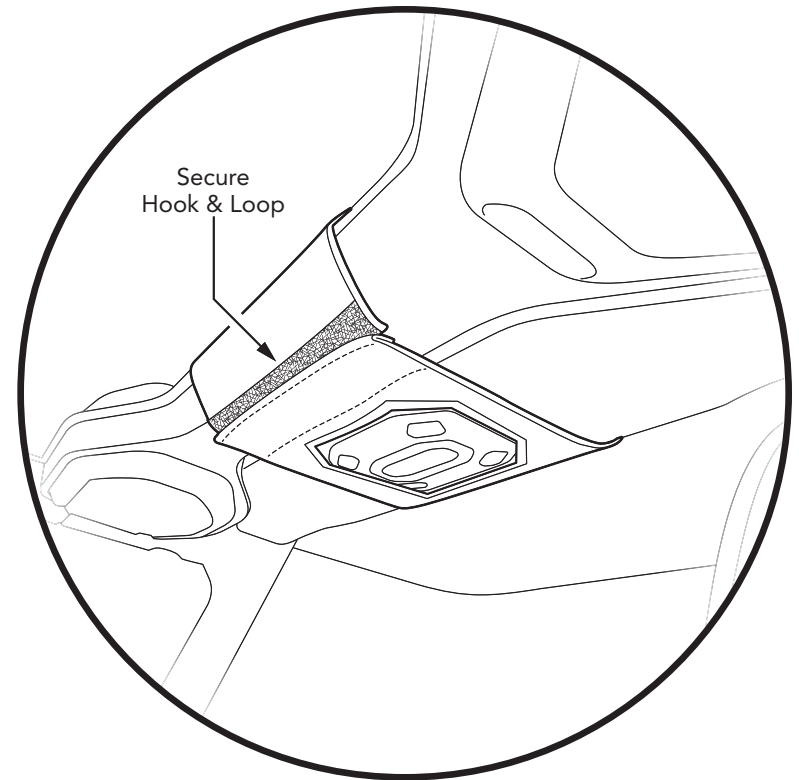
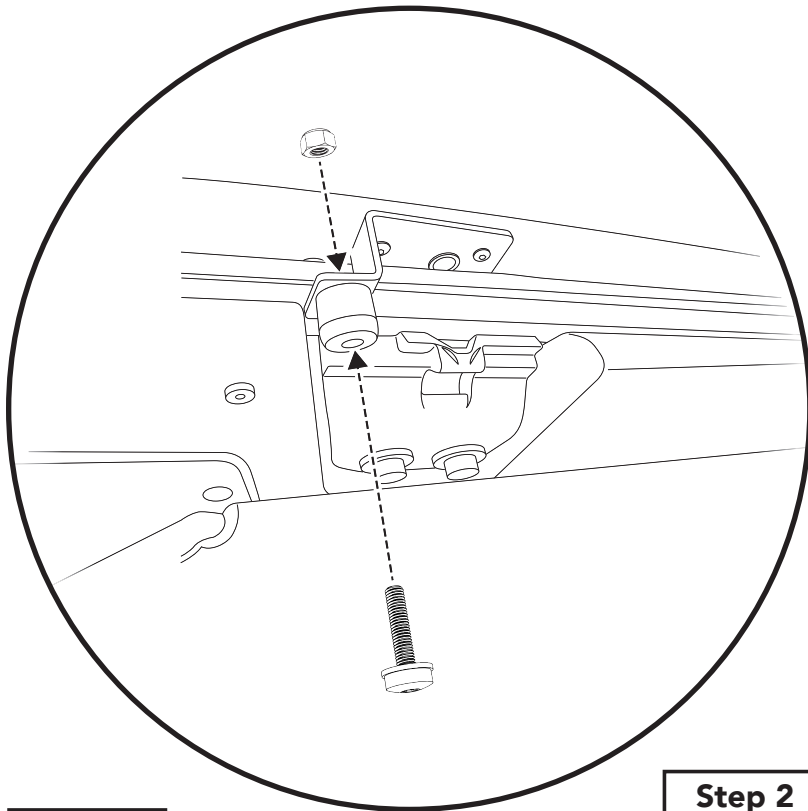

Step 1

Attach the M8x1.25x38 Button Head Socket Cap Screws #532.17 from the underside, and secure the pre-attached brackets on the Header Channel to the windshield header, using one (1) M8 Nylon Lock Nut #434.12 on top of each pre-attached bracket.

Step 2

Lay the fabric top back across the Jeep, over the soundbar and sportbar.

Step 2

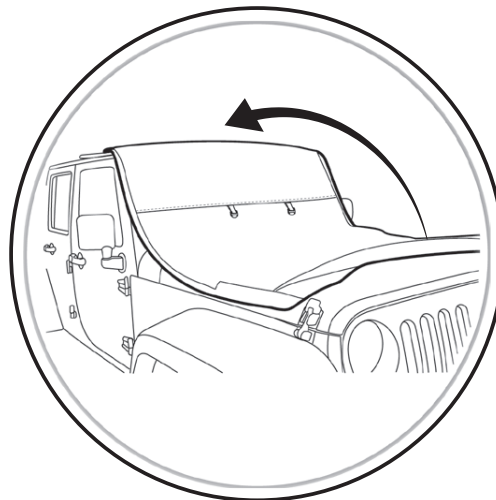

Step 3

Wrap the Soundbar Flap around the soundbar, and secure using the PSA Hook & Loop strip.

Make sure that all lights on the underside of the soundbar are exposed.

Step 1 589.20

Hardware

Step 2 Buckle Straps

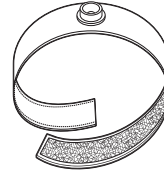
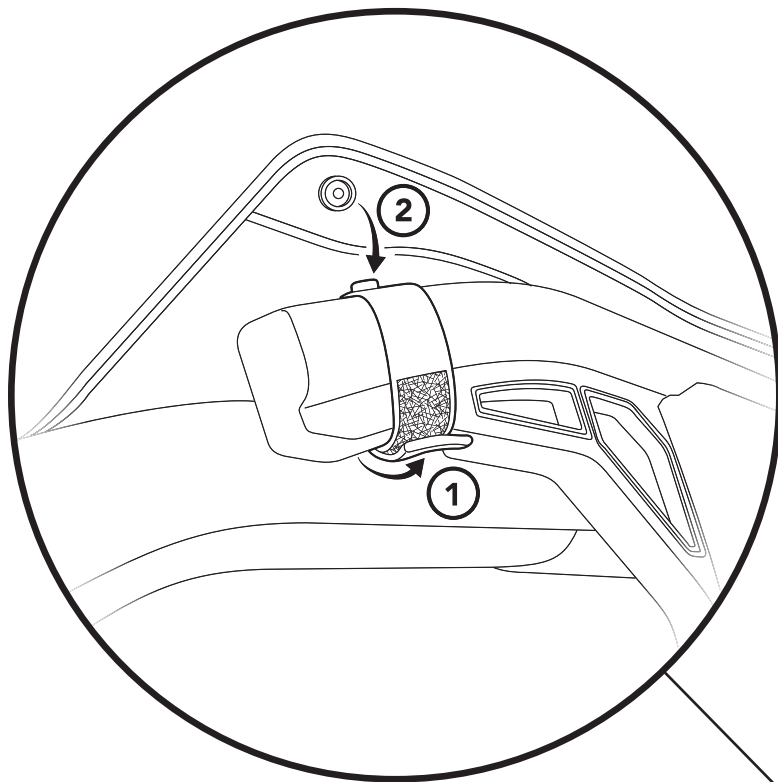

Hook & Loop Snap Straps
#589.20
Qty. 2

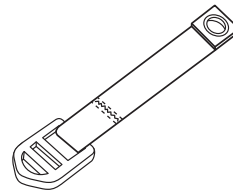

Buckle Straps
Qty. 2

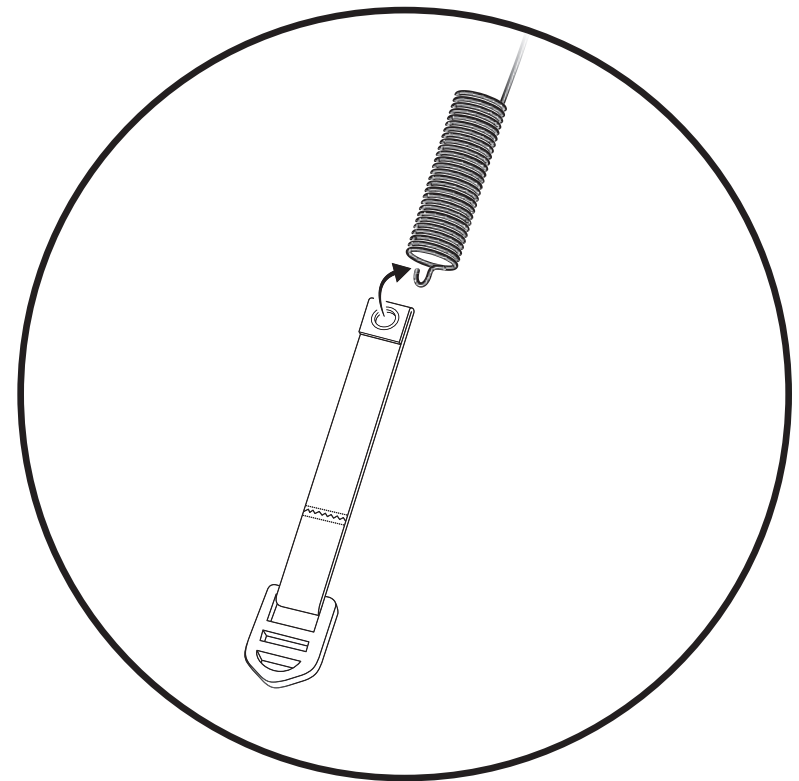

Step 1

Tightly wrap a Hook & Loop Snap Strap #589.20 around the rear leg of each rear Door Rail, with the snap on the top of the strap.

Snap each rear corner of the Cable Bikini Top to the Snap Straps.

NOTE: The Hook & Loop strip on the underside middle rear of the Bikini Top is for optional equipment.

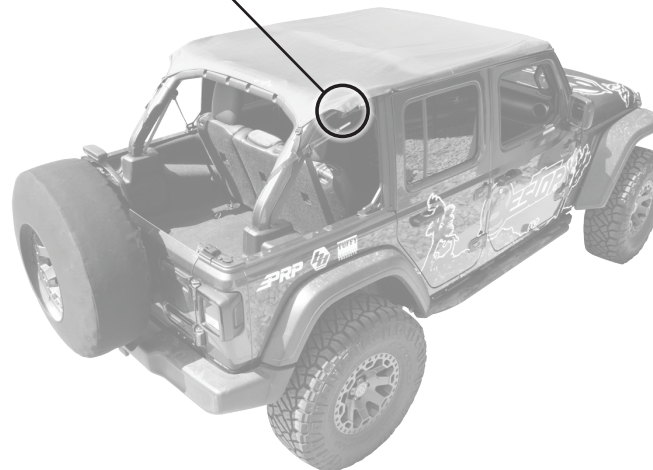

Step 2

Locate the spring on the end of each cable, where it exits the fabric top near the middle of the rear sport bar.

Attach the grommet end of each Buckle Strap to the end of the spring.

Step 1

Hardware

Step 2 Grommet Straps

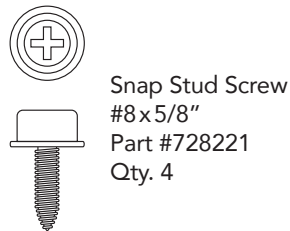
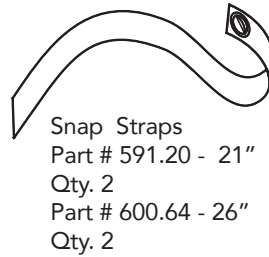
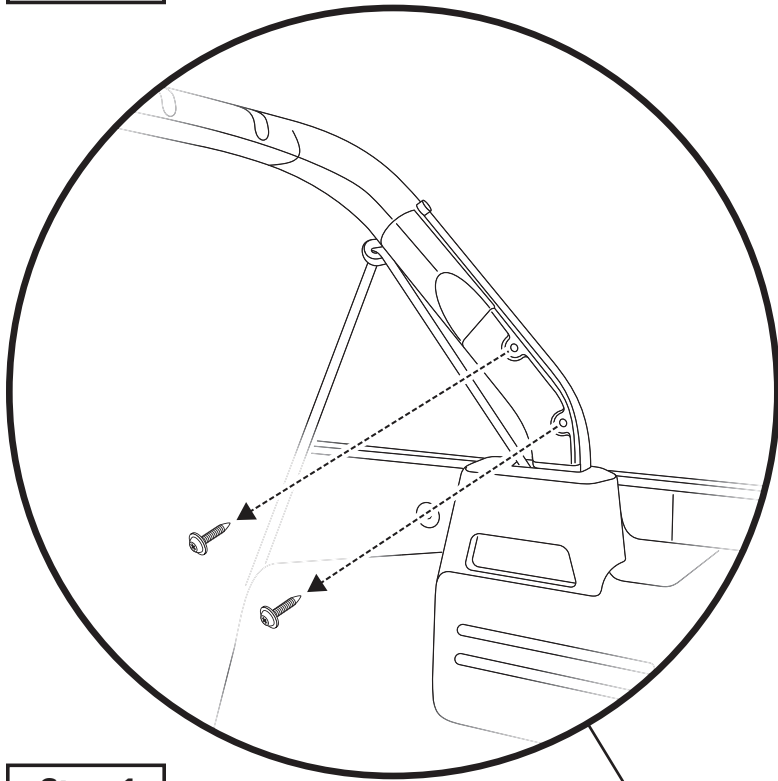

Tools



T25 Torx Driver
Phillips Driver

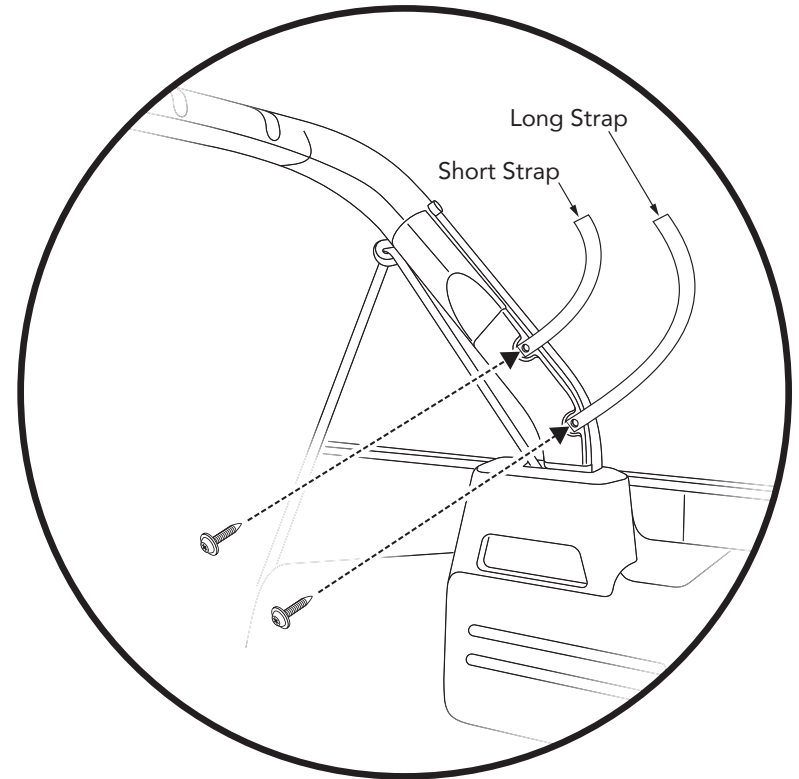

Step 1

Remove the two (2) Torx screws on the inside of each sport bar down tube.
Replace with 728221 Snap Stud Screw

Step 2

Using the 728221 Snap Screws, attach the Snap Straps to the sport bar down tubes in the locations where you removed the screws in the previous step.

Attach the Long (26") Straps in the bottom holes, and the Short (21") Straps in the upper holes.

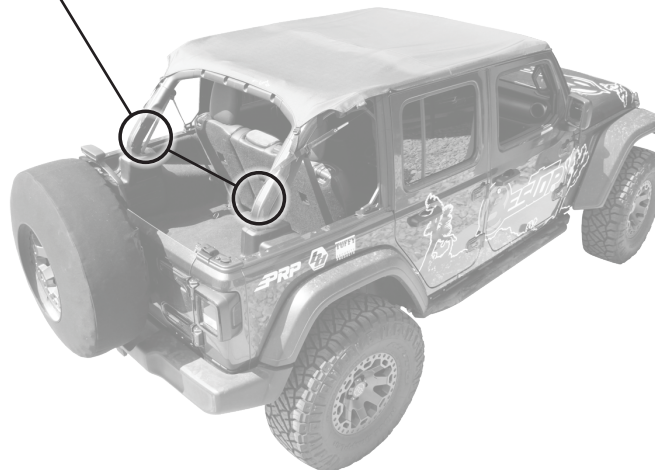

Step 1

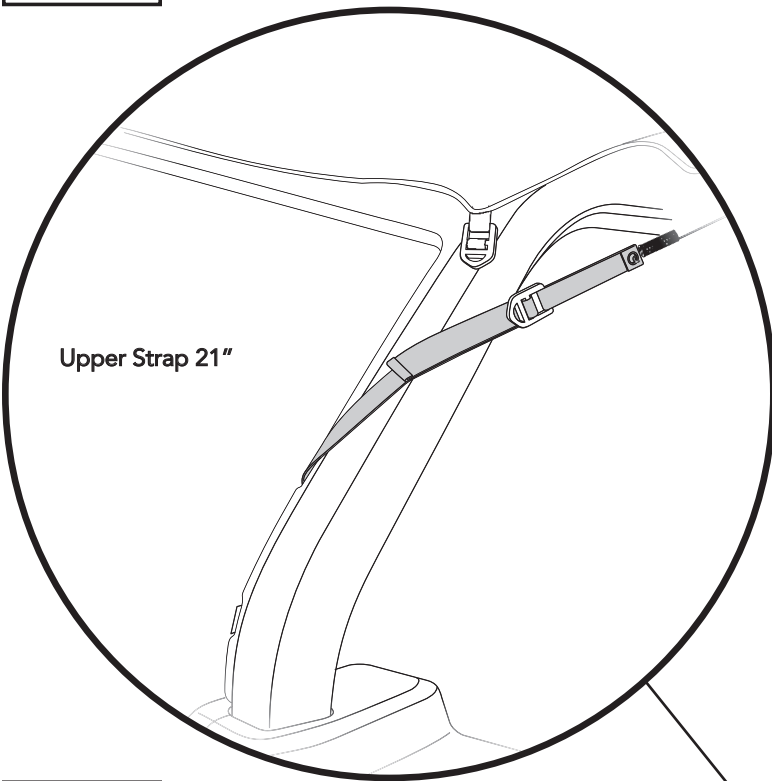

Hardware



Tail Clip
Part #338.24
Qty. 4

Step 2

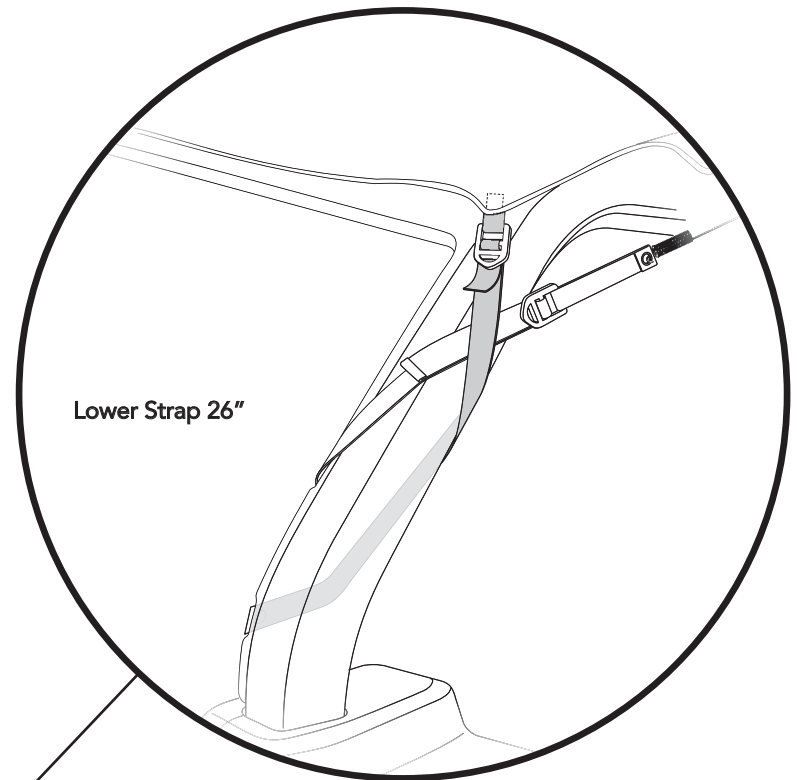

Step 1

Wrap the Upper (20" Short) Strap around the Sport Bar.

Wrap the strap over the top of the sport bar and attach the end of the Strap to the buckle at the end of the Spring Cable.

Cinch this strap down tightly.

NOTE: The Cable must go below the Shoulder Screw (shown on Page 6, section 2).

Step 2

Wrap the lower (26" Long) Strap around the Sport Bar.

Wrap the strap underneath the sport bar and around over the top, and attach the end of the Strap to the buckle at the corner of the Bikini Top. Cinch down tightly.

This Strap will go over the top of the previously installed Strap.

Dress loose strap ends using Tail Clips #338.24.

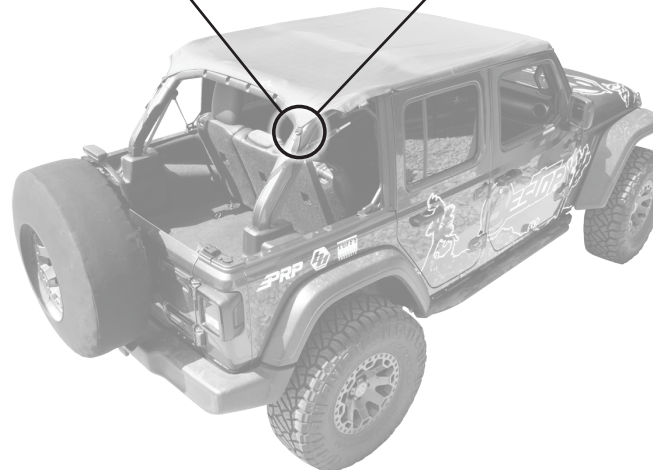



Care and Maintenance of your Bestop Product

Your Bestop product is made of the finest materials available. To keep it looking new and for the maximum possible wear, it will need periodic cleaning and maintenance.

Fabric: The fabric should be washed often using soap, warm water and a soft bristle brush. Rinse with clear water to remove all traces of soap. Bestop recommends using Bestop Cleaner (part no. 11201-00) and Bestop Protectant (part no. 11202-00) for Vinyl fabric and Bestop Twill Protectant (part no. 11207-00) for Twill fabric. Bestop Cleaner and Bestop protectant are specially formulated to provide a total cleaning and protection system. Bestop Cleaner safely removes the toughest stains, will not harm vehicle finishes, is biodegradable and environmentally friendly. Bestop Protectant protects against UV-fading, cracking and hardening, and repels dust, grease, dirt and mildew.

Windows: Keep windows clean to avoid scratching. DO NOT use a brush on the windows! Wash with a water-soaked cloth or sponge and a mild dishwashing detergent. Bestop recommends Bestop Vinyl Window Cleaner (part no. 11203-00), which safely cleans and protects vinyl windows and helps prevent UV damage. NEVER WIPE THE WINDOWS WHEN THEY ARE DRY. Be careful when cleaning snow or frost from the vinyl windows since they are easily scratched and may crack at low temperatures. DO NOT roll the sides or rear window in cold weather. The windows become stiff and will crack. Cracks caused by misuse in cold temperatures are not covered under warranty.

Water: Seeping through at the seams may be stopped by applying 3-M Scotchgard® on the inside of the seams.

Snaps: Keep snaps cleaned and lubricated with silicone to help prevent snaps from sticking to the studs. If a snap does become stuck to a stud, use a screwdriver and GENTLY pry apart to prevent permanent damage to the snap or the top fabric.

Zippers: Keeping zippers cleaned and lubricated with Bestop's Zipper Cleaner (part no. 11206-00) will help prevent damage and keep the zippers in smooth working condition. If a zipper opens behind the slider, the slider may have been spread apart. This problem can usually be repaired by using an ordinary pair of pliers to bring the sides back into parallel. Return slider to the end of the zipper in the normal Open position. Squeeze lightly at first and test the zipper. If the zipper continues to remain open squeeze more firmly with the pliers and try the zipper again. Repeat this procedure until the zipper operates correctly.

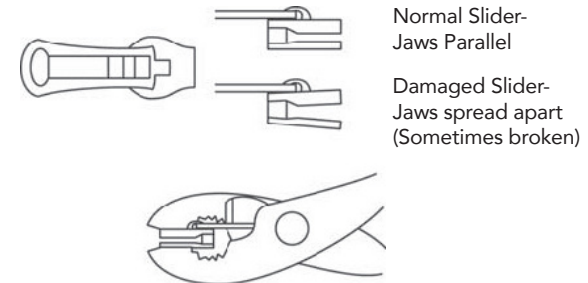

For Bestop Warranty Information, Please go to;
<https://www.bestop.com/help/warranty-information/>

